

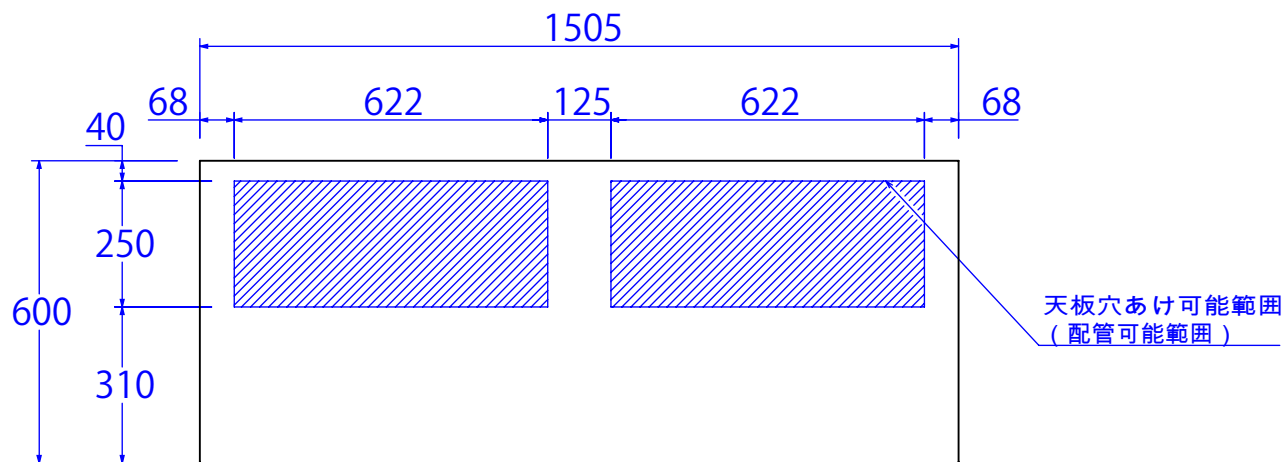

上面図

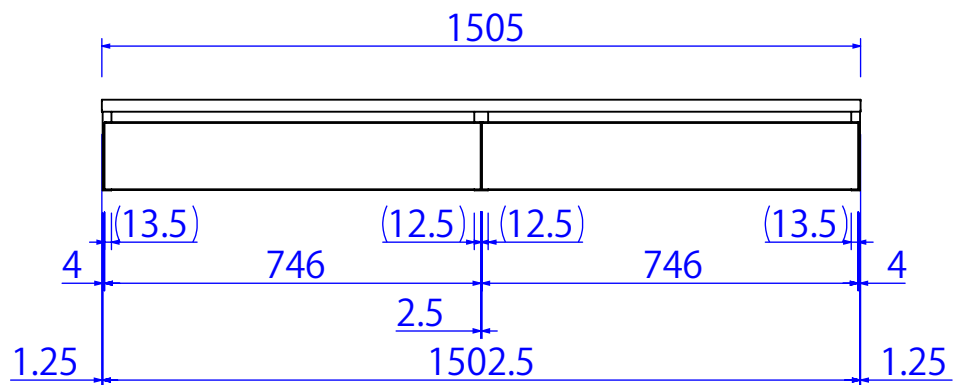

正面図



側面図

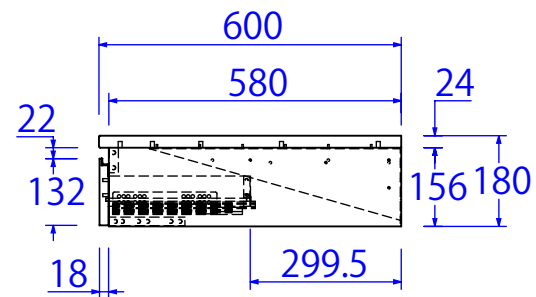

品名 MA-WS1501

パーツ名 天板穴あけ可能範囲